

One Hundred Years After Heisenberg: Discovering the World of Simultaneous Measurements of Noncommuting Observables

Carlton M. Caves

*Center for Quantum Information and Control
University of New Mexico*

<http://info.phys.unm.edu/~caves>

“Well, why not say that all the things which should be handled in theory are just those things which we also can hope to observe somehow.” ... I remember that when I first saw Einstein I had a talk with him about this. ... [H]e said, “That may be so, but still it's the wrong principle in philosophy.” And he explained that it is the theory finally which decides what can be observed and what can not and, therefore, one cannot before the theory, know what is observable and what not.

Werner Heisenberg, recalling a conversation with Einstein in 1926,
interviewed by Thomas S. Kuhn, February 15, 1963

This work was carried out with Christopher S. Jackson,
whose genius and vision inform every aspect.





**A brief glimpse into
a whole new world**

**Moo Stack and the Villians of Ure
Eshaness, Shetland**



A brief glimpse into a whole new world

Examples

Any set of Hermitian observables,

$$\vec{X} = \{X_1, \dots, X_n\},$$

can be measured (differential) weakly and simultaneously in an infinitesimal increment dt , without regard to commutators.

Single observable X

Position Q and momentum P

Three components of angular momentum, J_x , J_y , and J_z

Two components of angular momentum, J_x and J_y

Two squeezing symplectic generators, $K_x = \frac{1}{4}(Q^2 - P^2)$ and $K_y = -\frac{1}{4}(QP + PQ)$

Concatenating these differential weak measurements continuously should tell one what it means to measure the same observables strongly and simultaneously. And so it does, except that it also leads to . . .

A magic carpet ride

Into a whole new world.

A new, fantastic point of view,

A thrilling chase,

A wondrous space,

And now we bring this whole new world to you.

Big-time apologies to *Aladdin*



A brief glimpse into a whole new world

A magic carpet ride
Into a whole new world.
A new, fantastic point of view,
A thrilling chase,
A wondrous space,
And now we bring this whole new world to you.



Big-time apologies to *Aladdin*

The details in three papers
C. S. Jackson and C. M. Caves

“Simultaneous measurements of noncommuting observables: Positive transformations and instrumental Lie groups,” *Entropy* 25, 1254 (2023). (a.k.a. 1-2-3),
<https://doi.org/10.3390/e25091254>

“Simultaneous momentum and position measurement and the instrumental Weyl-Heisenberg group,” *Entropy* 25, 1221 (2023). (a.k.a. SPQM),
<https://doi.org/10.3390/e25081221>

“How to perform the coherent measurement of a curved phase space by continuous isotropic measurement. I. Spin and the Kraus-operator geometry of $SL(2,C)$,” *Quantum* 7, 1085 (2023), arXiv:2107.12396v3. (a.k.a ISM), <https://doi.org/10.22331/q-2023-08-16-1085>

plus

C. S. Jackson, “The photodetector, the heterodyne instrument, and the principle of instrument autonomy,” arXiv:2210.11100.



A brief glimpse into a whole new world

- ❑ Any set of observables can be measured simultaneously if measured differential weakly. Commutators can be disregarded for *differential weak measurements*.
- ❑ Differential weak measurements define a *fundamental incremental Kraus operator*, a *differential positive transformation*, which is the positive-operator analogue of an infinitesimal unitary transformation and equally fundamental.
- ❑ Instrument (Kraus-operator) evolution is *autonomous*, *temporal*, and *stochastic*.
- ❑ *Instrument Manifold Program*. The instrument evolution occurs on the manifold of an *instrumental Lie group*, which is generated by the measured observables.
- ❑ Motion of the Kraus operators on the instrumental Lie group is described using the three faces of the *stochastic trinity*: Wiener path integrals, stochastic differential equations, and a diffusion equation for a *Kraus-operator distribution function*.
- ❑ *Universal instruments*. The instrumental Lie group is generated universally, detached from and independent of Hilbert space.
- ❑ *Principal instruments* (e.g., measure position and momentum or three components of spin) have a low-dimensional universal instrumental group: they limit to coherent-state POVMs—*collapse within irrep*—and thus define a phase space, which is connected to the identity across a symmetric space. These instruments are special and universal (pre-quantum) and structure any Hilbert space in which they are represented; *principal instruments are what Heisenberg and Einstein meant when they talked about identifying what is observable*.
- ❑ *Chaotic instruments* (e.g., measure two components of spin or two squeezing symplectic generators) have an infinite-dimensional universal instrumental group: these are generic, evolve chaotically, and have no limiting strong measurement.

This talk is about thinking of instruments (measurements) in a new way, which places them at the foundation of quantum mechanics.

100 years of quantum measurements



**Pinnacles National Park
Central California**

100 years of quantum measurements. The founding (1925-32)

Matrix mechanics, commutators, and uncertainty principle
Wave mechanics (the Schrödinger equation)
Linear algebra of square-integrable functions
Dirac-Jordan transformation theory
Born probability rule

von Neumann's synthesis: inner products and Hilbert space, unitary transformations (Hamiltonian dynamics), and measurements of Hermitian observables.

von Neumann measurement of Hermitian observable

$$X = \sum_j \lambda_j |j\rangle\langle j| = \sum_j \lambda_j P_j$$

$$j, p_j = |\langle j|\psi\rangle|^2 = \langle \psi|P_j|\psi\rangle$$

Born rule

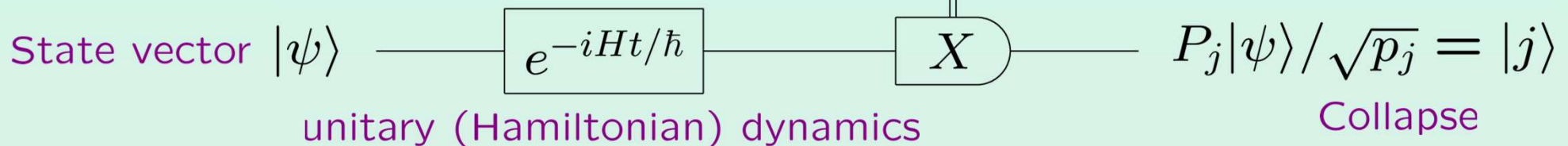

Temporal:
(continuous) *process*

Autonomous:
independent of state

Temporal	Autonomous	Transformation	Group
No	Yes	Yes	No

Drop $|\psi\rangle$ from description.

Physics by fiat:
no simultaneous
measurements of
noncommuting
observables

100 years of quantum measurements. The desert (1932-60)

Quantum measurement theory withered under the desert sun, whereas the unitary side of quantum mechanics thrived with constant and well-deserved nurturing.

Everybody used the Born rule, though how to interpret its probabilities and the quantum state itself remains a source of discussion and debate today. Nobody used and next to nobody bought von Neumann's collapse, because there were no repeated measurements on the same system.

All measurements were actually von Neumann's indirect measurements and analyzed using the Born rule without using von Neumann measurements of Hermitian observables.

Mathematical developments

Unitary Lie groups: symmetry groups and representation theory

Functional and harmonic analysis

Functional (path) integration

Transformation groups

Differential geometry of complex Lie groups

Measures and probability theory, stochastic processes, and stochastic calculus

First three and a bit of the fourth fell on fertile soil in the unitary sector of quantum mechanics and quantum field theory.

None of this got into (or was needed in) the desiccated quantum measurement theory.

We use all these developments.

100 years of quantum measurements.

Generalized measurement theory (1960-85)

Overcomplete-basis measurements (measurements of noncommuting observables, coherent states, heterodyne)

Hint of repeated measurements

Generalized measurement theory. Taking advantage of von Neumann's indirect measurements

Wigner
Davies
Ludwig
Kraus

Meter (ancilla)

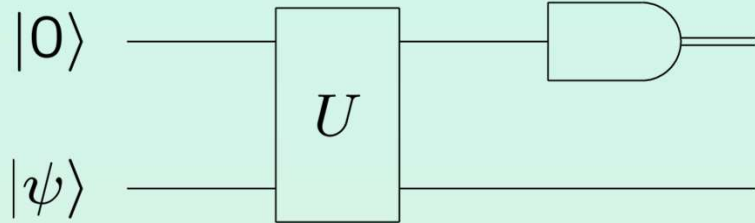

System

Born rule

$$j, p_j = \text{tr}_S(K_j|\psi\rangle\langle\psi|K_j^\dagger) = \text{tr}_S(E_j|\psi\rangle\langle\psi|)$$

$$\langle j|U|0\rangle|\psi\rangle/\sqrt{p_j} = K_j|\psi\rangle/\sqrt{p_j}$$

“Gentler” collapse

(Kraus operator) = $K_j = \langle j|U|0\rangle$

(POVM element) = $E_j = K_j^\dagger K_j \geq 0$

(Completeness): $\sum_j E_j = 1$

Positive

$$j, p_j = \langle\psi|E_j|\psi\rangle$$

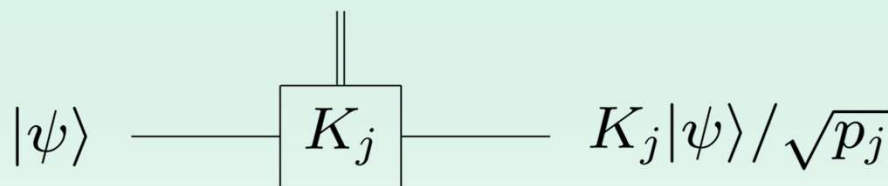
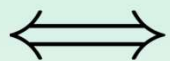

100 years of quantum measurements.

Generalized measurement theory (1960-85)

Concatenating measurements

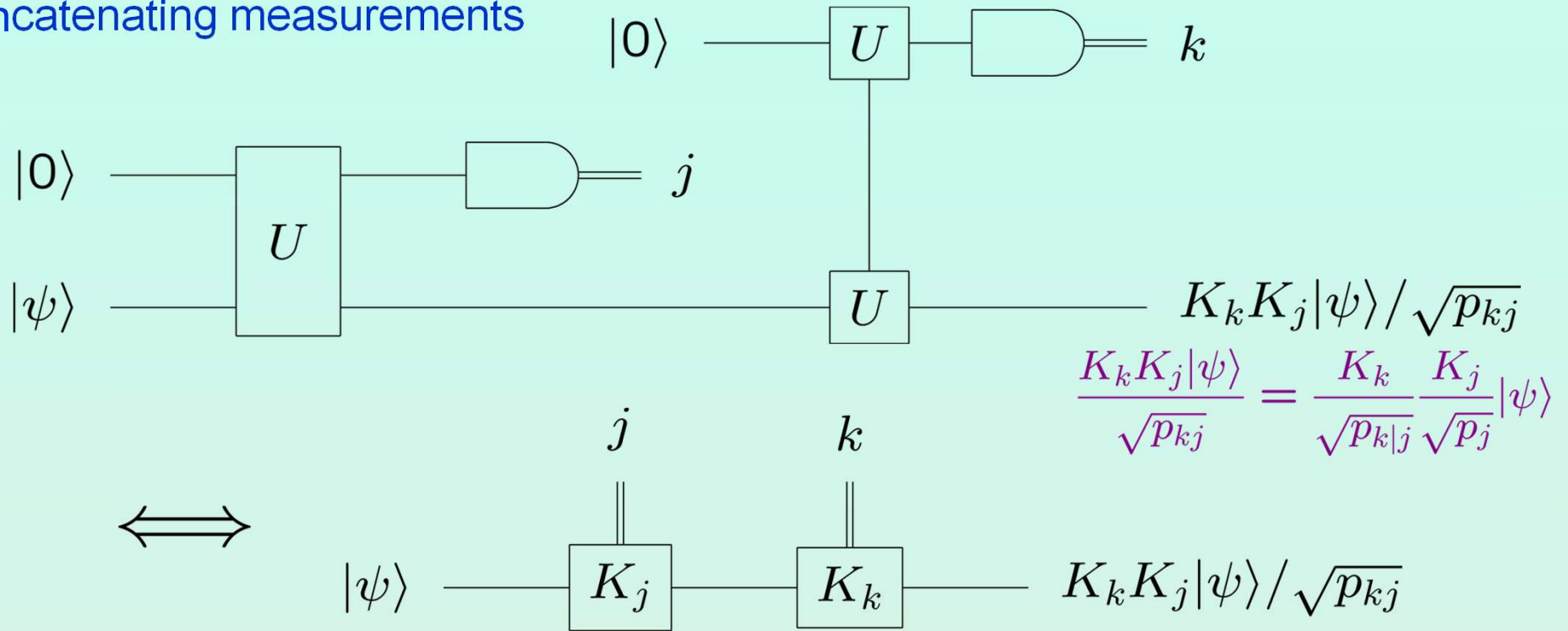

Temporal Gettin' there	Autonomous ?	Transformation Yes	Group No
---------------------------	-----------------	-----------------------	-------------

To normalize or not to normalize?

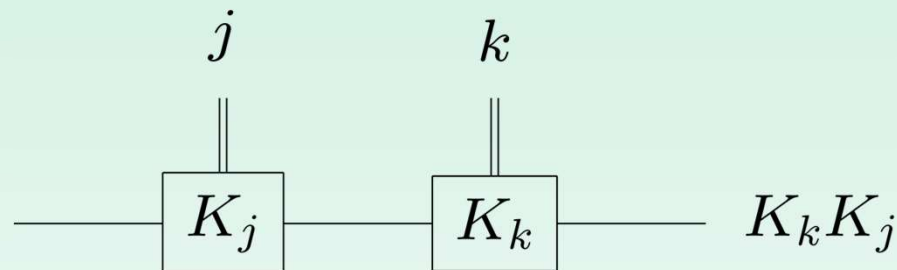

100 years of quantum measurements.

Continuous weak measurements (1980-2010)

We are interested in differential weak measurements:
Kraus operators close to the identity.

Davies	Doherty
Barchielli	Mabuchi
Carmichael	Jacobs
Milburn	Brun
Wiseman	Steck
Goetsch/Graham	

Differential weak measurement of X in increment dt

Meter wave function: $\langle q|0\rangle = \sqrt{\frac{1}{\sqrt{2\pi\sigma^2}}} e^{-q^2/2\sigma^2}$

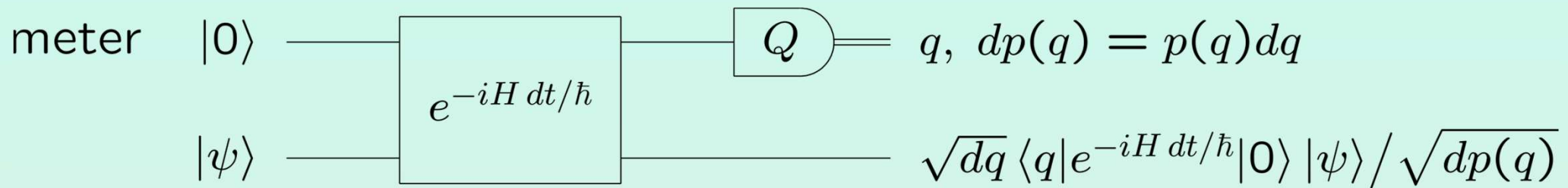

$H dt = 2\sqrt{\kappa dt} \sigma P \otimes X$
Controlled displacement
of meter position Q by X

$dW = q\sqrt{dt}/\sigma$ is a Wiener outcome increment.
 $d\mu(dW) =$ zero-mean Gaussian with $\langle dW^2 \rangle = dt$

Kraus operator

$$\sqrt{dq} \langle q|e^{-iH dt/\hbar}|0\rangle = \sqrt{d\mu(dW)} \underbrace{e^{X\sqrt{\kappa}dW - X^2\kappa dt}}_{= L_X(dW)}$$

$$dp(q) = d\mu(dW) \langle \psi | L_X(dW)^\dagger L_X(dW) | \psi \rangle$$

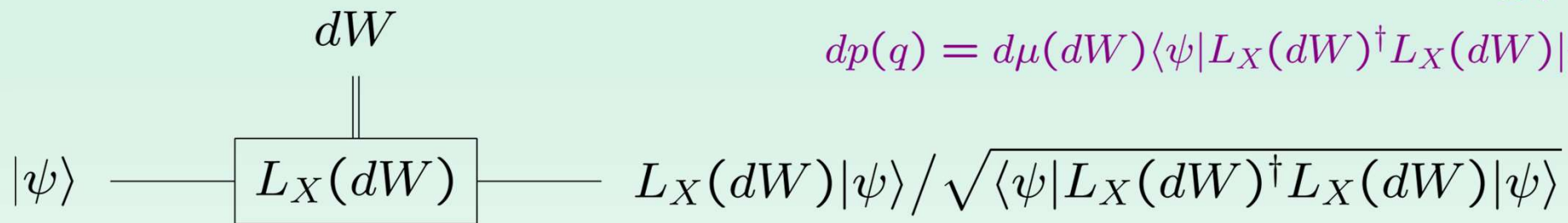

100 years of quantum measurements.

Continuous weak measurements (1980-2010)

Concatenating: Continuous, differential weak measurement of X over finite time T .

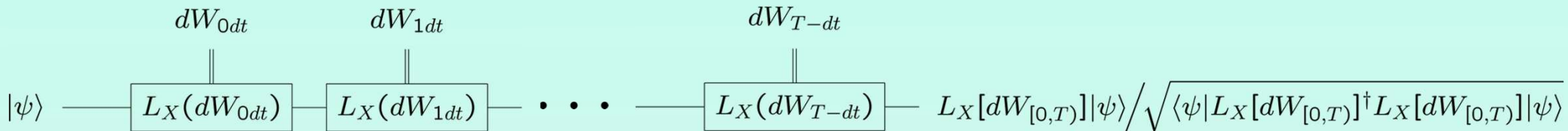

$$L_X(dW_t) = e^{\delta_t} = e^{X\sqrt{\kappa}dW_t - X^2\kappa dt}$$

$$\delta_t \equiv X\sqrt{\kappa}dW_t - X^2\kappa dt = (\text{forward generator})$$

$$L[dW_{[0,T)}] = \mathcal{T} \prod_{k=0}^{T/dt-1} L_X(dW_{kdt})$$

$$= \mathcal{T} \exp\left(\int_0^{T-dt} X\sqrt{\kappa}dW_t - X^2\kappa dt\right)$$

Temporal	Autonomous	Transformation	Group
Yes	?	Yes	?

Normalizing at each increment gives a stochastic master equation for an evolving state. Not normalizing (sometimes called a linear quantum trajectory) gives autonomous instrument evolution and a group.

100 years of quantum measurements.

Continuous weak measurements (1980-2010)

Continuous, differential weak measurement of X over finite time T .

Instrument evolution

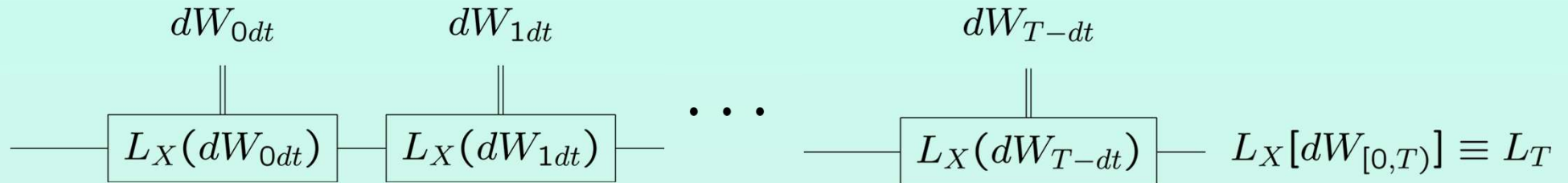

$$L_X(dW_t) = e^{\delta_t} = e^{X\sqrt{\kappa}dW_t - X^2\kappa dt}, \quad \delta_t \equiv X\sqrt{\kappa}dW_t - X^2\kappa dt = (\text{forward generator})$$

$$L[dW_{[0,T)}] = \mathcal{T} \prod_{k=0}^{T/dt-1} L_X(dW_{kdt}) = \mathcal{T} \exp\left(\int_0^{T-dt} X\sqrt{\kappa}dW_t - X^2\kappa dt\right)$$

Temporal	Autonomous	Transformation	Group
Yes	Yes	Yes	Yes

Continuous measurements of a single observable are trivial because everything commutes (time ordering is irrelevant; irreps are 1D). They limit to a strong measurement that is a von Neumann measurement (standard collapse between irreps).

**Variegated fairy wren
Oxley Common, Brisbane**

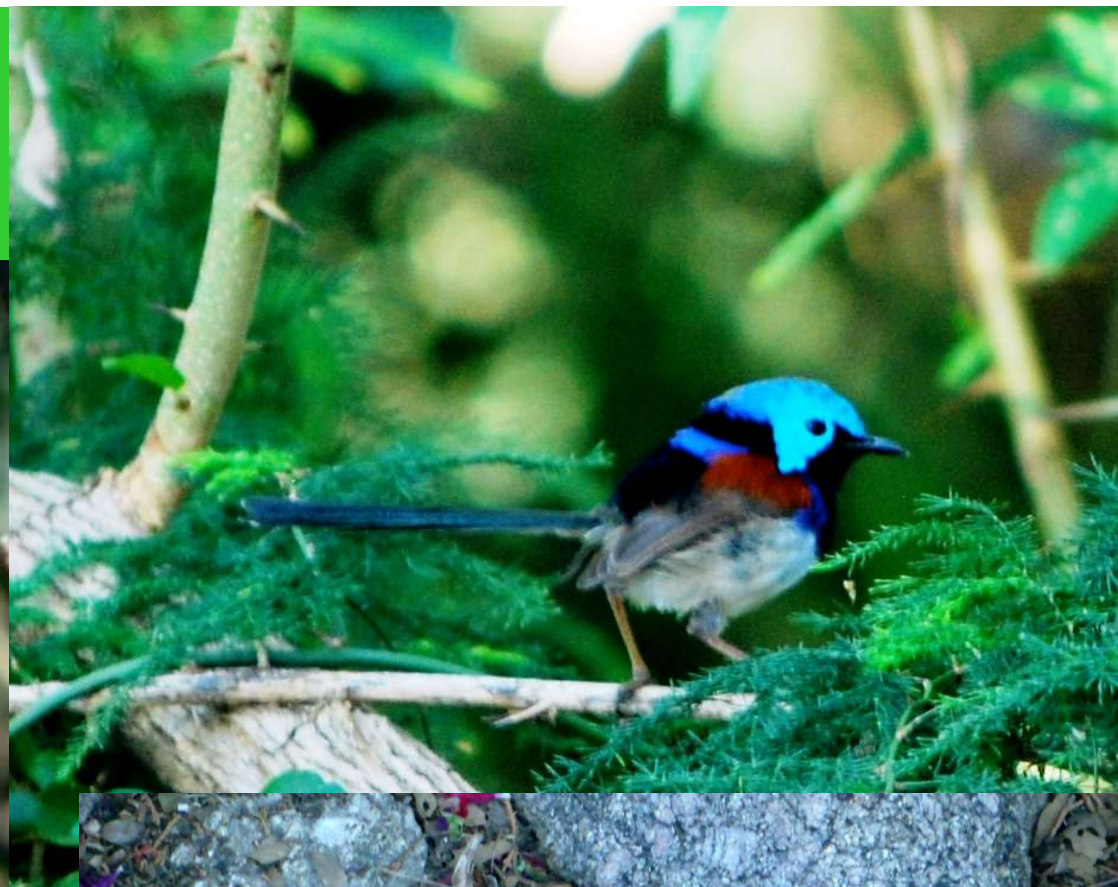

**Red-backed fairy wren
Oxley Common, Brisbane**



Instrument manifold program

**Western diamondback rattlesnake
My front yard, Sandia Heights**



Instrument manifold program

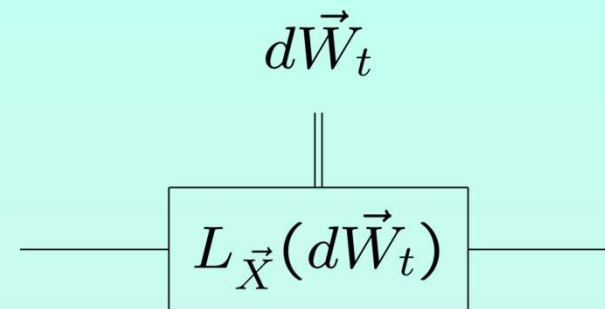

The incremental Kraus operator for a differential weak measurement of n (noncommuting) observables $\vec{X} = \{X_1, \dots, X_n\}$, beginning at time t for an increment dt , is

$$\sqrt{d\mu(d\vec{W}_t)} L_{\vec{X}}(d\vec{W}_t) = \sqrt{d(dW_t^1) \cdots d(dW_t^n)} \frac{e^{-d\vec{W}_t \cdot d\vec{W}_t / 2dt}}{(2\pi dt)^{n/2}} e^{\vec{X} \cdot \sqrt{\kappa} d\vec{W}_t - \vec{X}^2 \kappa dt},$$

Commutators can be disregarded for differential weak measurements.

Exponentials for different observables can be combined into a single exponential at order dt —commutators ignored—because the Wiener outcome increments are uncorrelated.

$$L_{\vec{X}}(d\vec{W}_t) = e^{\delta_t}, \quad \delta_t \equiv \vec{X} \cdot \sqrt{\kappa} d\vec{W}_t - \vec{X}^2 \kappa dt = (\text{forward generator})$$

Differential weak measurements define a *fundamental incremental Kraus operator*, a *differential positive transformation*, which is fundamental in the same way as infinitesimal unitary transformations.

$$\vec{X} \cdot d\vec{W}_t = \sum_{\mu} X_{\mu} dW_t^{\mu}, \quad dW_t^{\mu} = (\text{Wiener outcome increment for } X_{\mu})$$

$$\vec{X}^2 = \vec{X} \cdot \vec{X} = \sum_{\mu} X_{\mu}^2 = (\text{quadratic term}).$$

Instrument manifold program

Instrument evolution: “piling up” Kraus operators

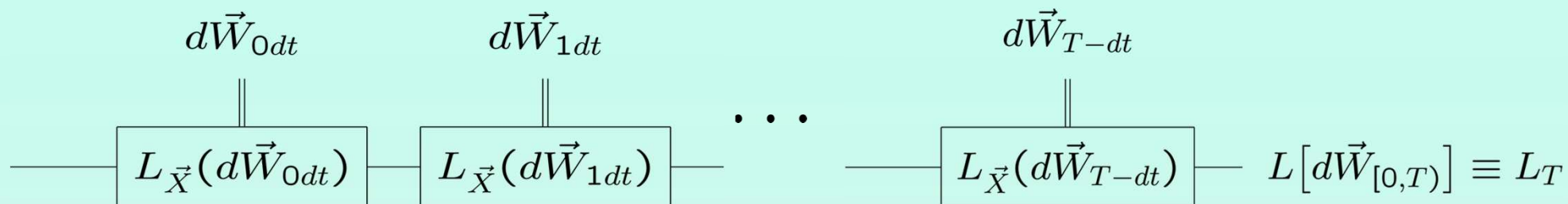

$$L_{\vec{X}}(d\vec{W}_t) = e^{\delta_t} = e^{\vec{X} \cdot \sqrt{\kappa} d\vec{W}_t - \vec{X}^2 \kappa dt}$$

The differential positive transformations “pile up” as successive incremental measurements are performed; at time T the Kraus operator is

$$L_T = L[d\vec{W}_{[0,T]}] = \mathcal{T} \exp \left(\int_0^{T-dt} \delta_t \right) = \mathcal{T} \exp \left(\int_0^{T-dt} \vec{X} \cdot \sqrt{\kappa} d\vec{W}_t - \vec{X}^2 \kappa dt \right),$$

where $d\vec{W}_{[0,T]}$ is the Wiener outcome path and \mathcal{T} denotes a time-ordered exponential—commutators do count for finite T ! The measuring *instrument* is the collection of these Kraus operators for all Wiener paths (more precisely, the collection of *instrument elements* $L_T \odot L_T^\dagger$).

Instrument evolution is an *autonomous, temporal, stochastic process*.

Instrument manifold program

Instrument evolution

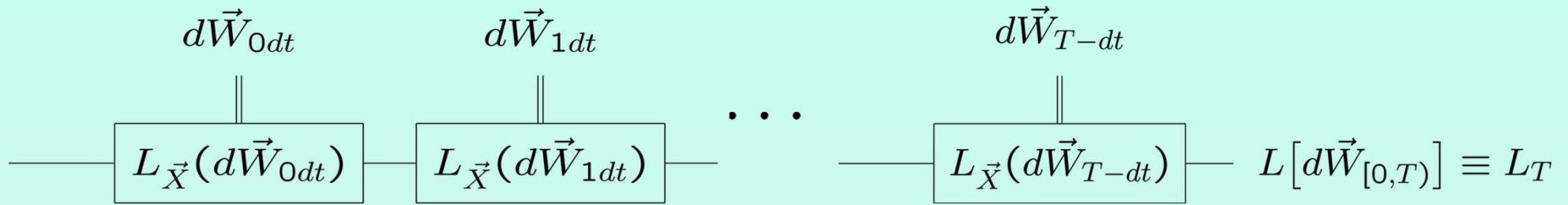

$$L_{\vec{X}}(d\vec{W}_t) = e^{\delta_t} = e^{\vec{X} \cdot \sqrt{\kappa} d\vec{W}_t - \vec{X}^2 \kappa dt}$$

The quantum circuit becomes a stochastic path on the instrumental Lie group manifold.

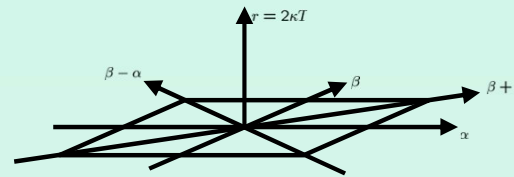
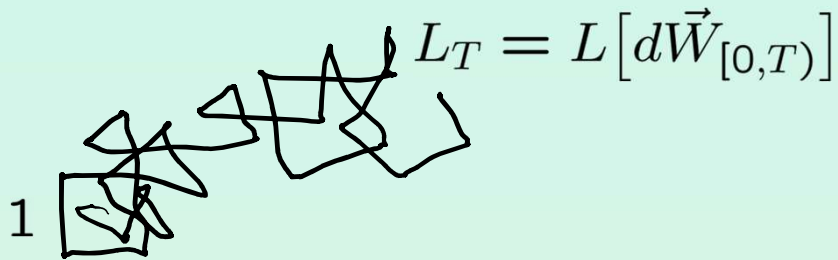

SPQM

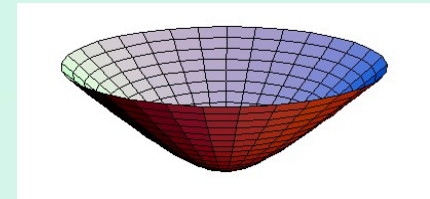

ISM

The Kraus operators $L_T = L[d\vec{W}_{[0,T)}]$ are elements of an *instrumental Lie group* G , which is the group generated by the measured observables, $\vec{X} = \{X_1, \dots, X_n\}$, and the *quadratic term*, $\vec{X}^2 = \vec{X} \cdot \vec{X} = \sum_{\mu} X_{\mu}^2$. The instrument evolves stochastically in the manifold of the instrumental Lie group, which is the natural setting for the measurement.

Heart of the *Instrument Manifold Program*:
Instrumental Lie groups.

Instrument manifold program. How we do it.

The motion of the Kraus operators on the group manifold G is analyzed using the three faces of the *stochastic trinity*. The overall quantum operation is given by a Wiener-like path integral of the measurement record,

$$Z_T = \int \mathcal{D}\mu[d\vec{W}_{[0,T)}] L[d\vec{W}_{[0,T)}] \odot L[d\vec{W}_{[0,T)}]^\dagger;$$

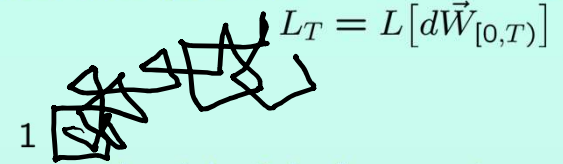

it is the solution of a Lindblad equation in which the measured observables are the Lindblad operators. The Kraus-operator paths satisfy a *stochastic differential equation* (SDE),

Maurer-Cartan form (Stratonovich): $dL_t L_{t+dt/2}^{-1} = \delta_t = \vec{X} \cdot \sqrt{\kappa} d\vec{W} - \vec{X}^2 \kappa dt,$

Modified MC stochastic differential (Itô): $dL_t L_t^{-1} - \frac{1}{2}(dL_t L_t^{-1})^2 = \delta_t.$

Stochastic differential equation

A *Kraus-operator distribution function* (KOD) is defined by a Wiener path integral,

$$D_T(L) \equiv \int \mathcal{D}\mu[d\vec{W}_{[0,T)}] \delta(L, L[d\vec{W}_{[0,T)}]),$$

Wiener path integral

where the δ -function is defined relative to the Haar measure of G . The KOD evolves according to a *Fokker-Planck-Kolmogorov equation* (FPKE),

$$\frac{1}{\kappa} \frac{\partial D_t(L)}{\partial t} = \Delta[D_t](L), \quad \Delta \equiv \overleftarrow{\vec{X}}^2 + \frac{1}{2} \sum_{\mu} \overleftarrow{X}_{\mu} \overleftarrow{X}_{\mu},$$

Diffusion equation

where the underarrows denote *right-invariant derivatives*,

$$\overleftarrow{X}[f](L) \equiv \left. \frac{d}{dh} f(e^{hX} L) \right|_{h=0} = \lim_{h \rightarrow 0} \frac{f(e^{hX} L) - f(L)}{h},$$

these being the natural vector fields on the instrumental Lie-group manifold. Notice that $\overleftarrow{\vec{X}}^2$ describes ballistic motion and

$$\nabla^2 \equiv \sum_{\mu} \overleftarrow{X}_{\mu} \overleftarrow{X}_{\mu}$$

Stochastic trinity

is a Laplacian that describes diffusion.

Instrument manifold program

The Lie algebra for the instrumental Lie group can be processed using the matrices of a particular representation or processed *universally*, using only the commutators, within what is called the *universal enveloping algebra*. The *universal instrumental Lie group* is called the *universal covering group*; it is detached from Hilbert space.

Universal instruments detached from Hilbert space.

Special measurements, such as simultaneous momentum and position measurement (SPQM) and isotropic measurement of the three spin components (ISM), have a low-dimensional universal instrumental group; the instrument's POVM approaches a boundary of coherent states at late times, which is the strong measurement of the observables (we call this collapse within irrep). These instruments we call *principal instruments*. They connect classical phase space to the identity across a *symmetric space*.

Generic measurements—e.g., two components of spin, two squeezing symplectic generators—have an infinite-dimensional universal instrumental group; the instrument's evolution is chaotic, and there is no universal strong measurement of the observables. These instruments we call *chaotic instruments*.

Principal universal instruments. Very special. Pre-quantum.
Coherent-state POVMs and phase space; collapse within irrep; phase space connected to the identity across a symmetric space.

Chaotic universal instruments. Generic.
Chaotic evolution and no limiting universal strong measurement.

SPQM, ISM, and chaos

**Truchas from East Pecos Baldy
Sangre de Cristo Range, northern New Mexico**

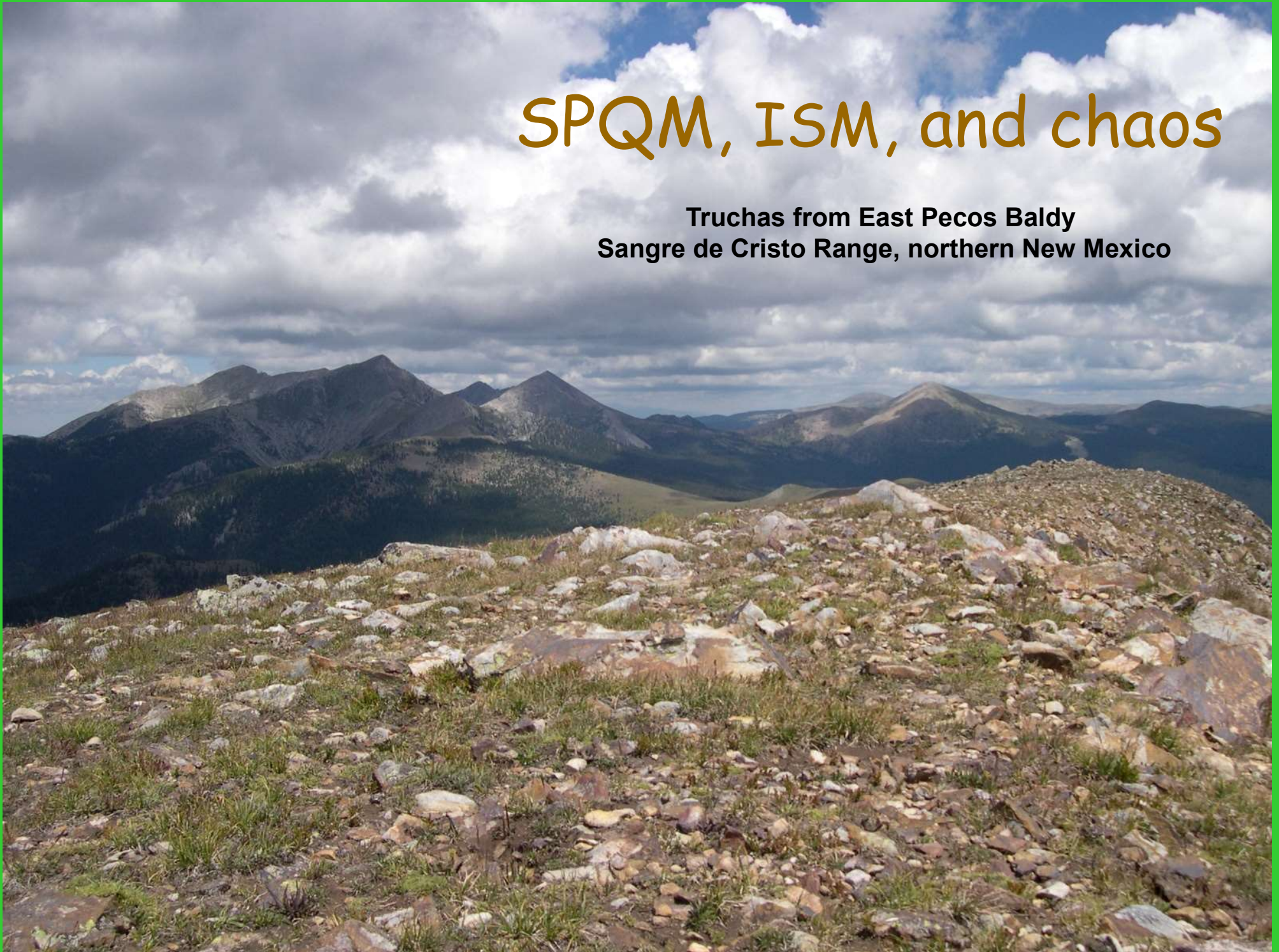

Simultaneous momentum and position measurement (SPQM): A principal instrument

Measure position Q and momentum P .

$$\text{Commutator: } [Q, P] = i1$$

$$\text{Quadratic term: } Q^2 + P^2 = 2H_0$$

7D instrumental Lie algebra: $\text{span}\{1, i1, iQ, -iP, Q, P, H_0\}$

7D instrumental Lie group, the *Instrumental Weyl-Heisenberg Group*,
 $\text{IWH} = \mathbb{C}\text{WH} \rtimes e^{\mathbb{R}H_0}$,

Coördinate manifold with Cartan-like decomposition,
 a group-theoretic singular-value decomposition,

$$\text{Kraus operator } L = (D_\beta e^{i1\phi}) e^{-H_0 r - 1\ell} D_\alpha^\dagger$$

D_β and D_α are phase-plane displacement operators.

$$\text{POVM element } E = L^\dagger L = e^{-2\ell 1} D_\alpha e^{-H_0 2r} D_\alpha^\dagger$$

Base manifold of positive transformations

$(\ell, \phi) = (\text{center normalization and phase})$

$r = (\text{ruler/purity}), \quad dr = 2\kappa dt, \quad r = 2\kappa t$ is ballistic

$\beta = (\text{post-measurement phase-plane})$

$\alpha = (\text{POVM phase-plane})$

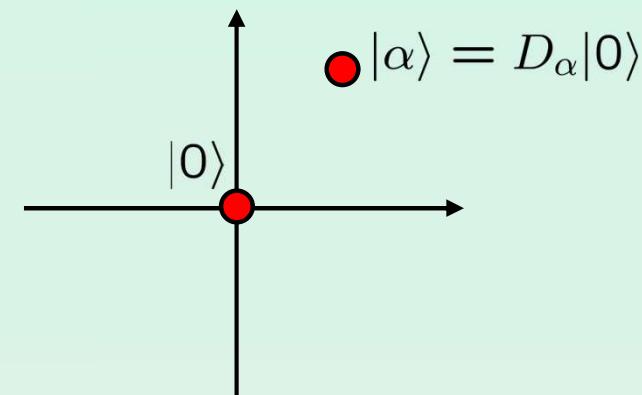

Write the SDEs and FPKE
 in these coördinates.

$$r = 0 : \quad E = L^\dagger L = e^{-2\ell} 1$$

$$r \rightarrow \infty : \quad E = L^\dagger L = e^{-2\ell} |\alpha\rangle\langle\alpha|$$

SPQM: A principal instrument

Kraus operator $L = (D_\beta e^{i1\phi}) e^{-H_0 r - 1l} D_\alpha^\dagger$

POVM element $E = L^\dagger L = e^{-2l1} D_\alpha e^{-H_0 2r} D_\alpha^\dagger$

(l, ϕ) = (center normalization and phase)

r = (ruler/purity), $dr = 2\kappa dt$, $r = 2\kappa t$ is ballistic

β = (post-measurement phase-plane)

α = (POVM phase-plane)

Work in the coset of the center $Z = \{e^{1(-l+i\phi)}\}$;
i.e., identify points with different center coordinates l and ϕ .

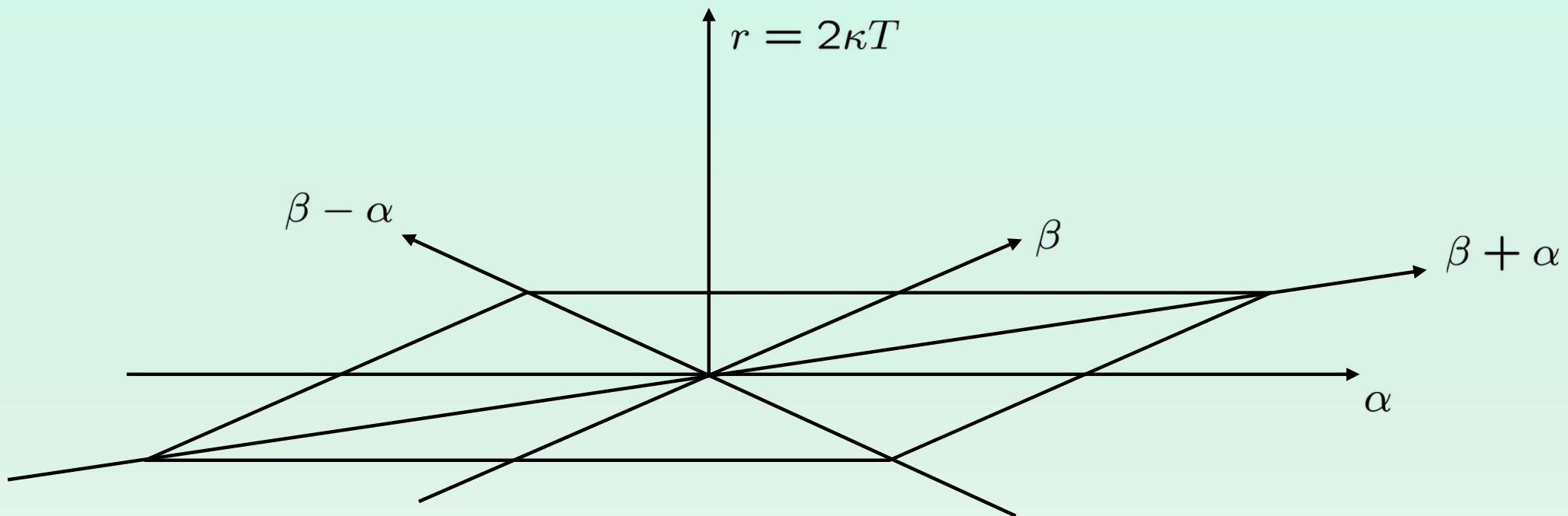

SPQM: A principal instrument

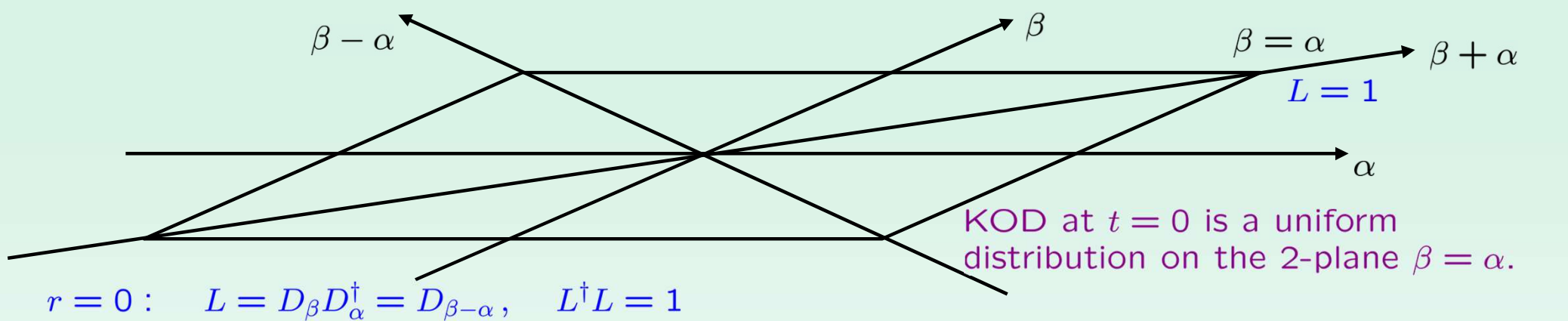
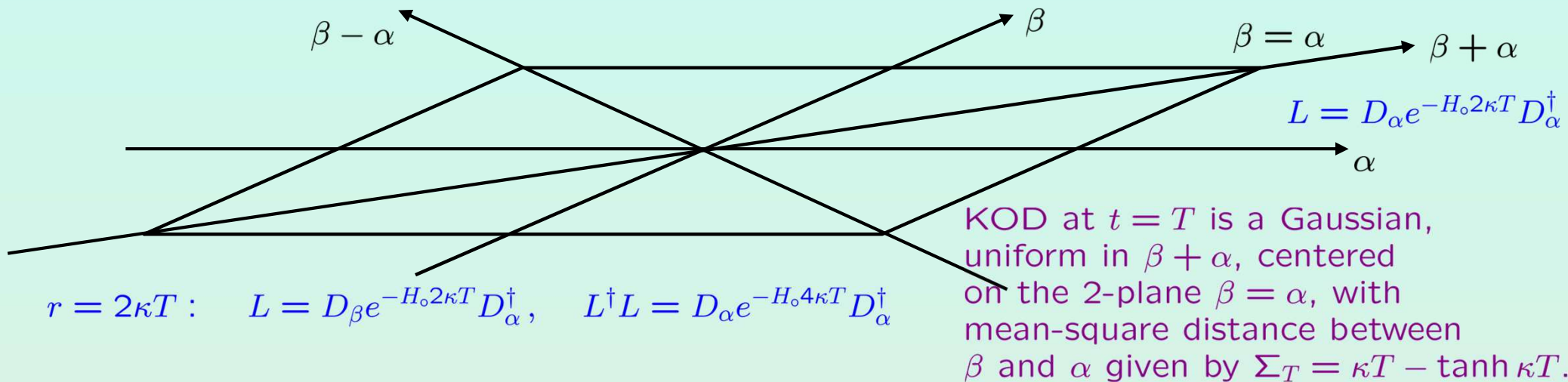
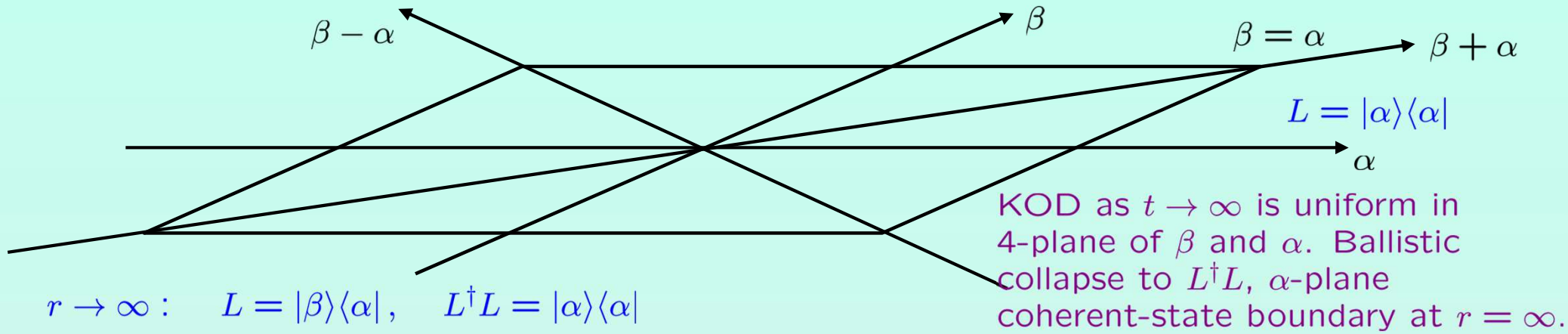

Isotropic spin measurement (ISM): A principal instrument

Measure J_x , J_y , and J_z .

Commutators: $[J_\mu, J_\nu] = i\epsilon_{\mu\nu\eta}J_\eta$

Quadratic term: $J_x^2 + J_y^2 + J_z^2 = \vec{J}^2 = \text{Casimir invariant} = 1_j j(j+1)$

7D instrumental Lie algebra: $\text{span}\{-iJ_x, -iJ_y, -iJ_z, J_x, J_y, J_z, \vec{J}^2\}$

7D instrumental Lie group, the *Instrumental Spin Group*, $\text{ISpin}(3) = \text{SL}(2, \mathbb{C}) \times e^{\mathbb{R}\vec{J}^2}$

Coördinate manifold with Cartan decomposition,
group-theoretic singular-value decomposition,

Kraus operator $L = (D_{\hat{m}} e^{-iJ_z \psi}) e^{-\vec{J}^2 \ell + J_z a} D_{\hat{n}}^\dagger$

$D_{\hat{m}}$ and $D_{\hat{n}}$ are spherical displacement operators.

POVM element $E = L^\dagger L = e^{-\vec{J}^2 2\ell} D_{\hat{n}} e^{J_z 2a} D_{\hat{n}}^\dagger$

Base manifold (symmetric space)
of positive transformations.

$\ell =$ (center normalization), $d\ell = \kappa dt$,

$\ell = \kappa t$ is ballistic

$\psi =$ (geodesic curvature between past and future)

$a =$ (radial/purity), $da_t = \kappa dt \coth a_t + \sqrt{\kappa} dY_t^z$,

a is ballistic and diffusive

$\hat{m} =$ (post-measurement Bloch sphere)

$\hat{n} =$ (POVM Bloch sphere)

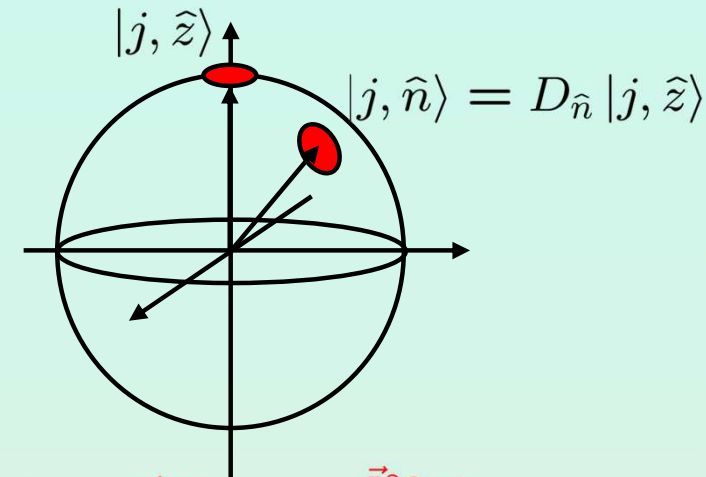

$$a = 0 : L^\dagger L = e^{-\vec{J}^2 2\kappa t}$$

$$a \rightarrow \infty : L^\dagger L \propto e^{-\vec{J}^2 2\kappa t} |j, \hat{n}\rangle \langle j, \hat{n}|$$

Write the SDE and FPKE
in these coördinates.

ISM: A principal instrument

Coördinate manifold with Cartan decomposition,
group-theoretic singular-value decomposition,

$$\text{Kraus operator } L = (D_{\hat{m}} e^{-iJ_z \psi}) e^{-\vec{J}^2 \ell + J_z a} D_{\hat{n}}^\dagger$$

$$\text{POVM element } E = L^\dagger L = e^{-\vec{J}^2 2\ell} D_{\hat{n}} e^{J_z 2a} D_{\hat{n}}^\dagger$$

$\ell =$ (center normalization), $d\ell = \kappa dt$,

$\ell = \kappa t$ is ballistic

$\psi =$ (geodesic curvature between past and future)

$a =$ (radial/purity), $da_t = \kappa dt \coth a_t + \sqrt{\kappa} dY_t^z$,

a is ballistic and diffusive

$\hat{m} =$ (post-measurement Bloch sphere)

$\hat{n} =$ (POVM Bloch sphere)

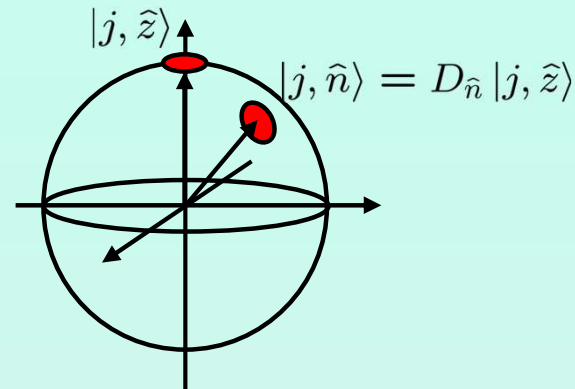

$$a = 0 : L^\dagger L = e^{-\vec{J}^2 2\kappa t}$$

$$a \rightarrow \infty : L^\dagger L \propto e^{-\vec{J}^2 2\kappa t} |j, \hat{n}\rangle \langle j, \hat{n}|$$

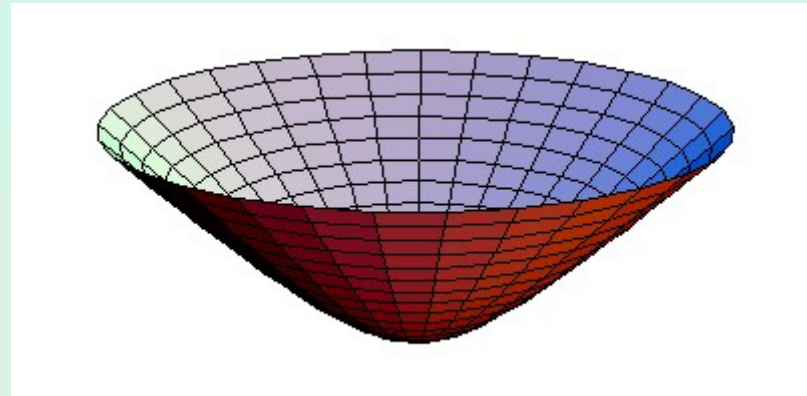

The base manifold of positive transformations (POVM elements) is a symmetric space, in this case a 3-hyperboloid of constant negative curvature, coördinated by a and \hat{n} .

To get the induced geometry right, one regards the hyperboloid as embedded in Minkowski space, not Euclidean space.

ISM: A principal instrument

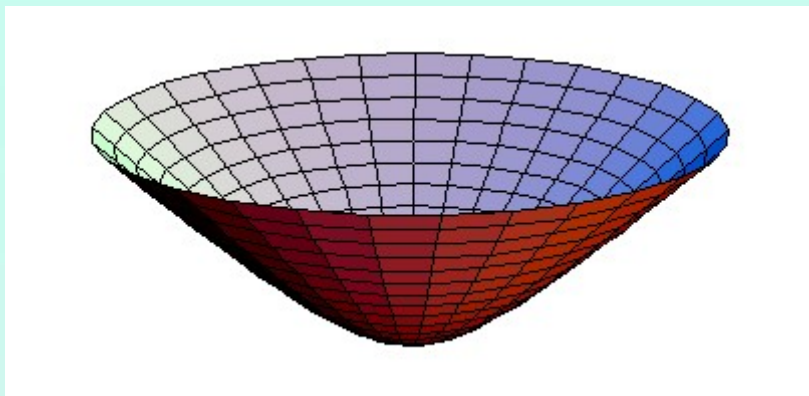

The angular diffusion of the POVM displacement is overwhelmed by the area exponentiation.

Nearly ballistic “collapse” to the coherent-state boundary at $a = \infty$.

$$E = D_{\hat{n}} e^{J_z 2a} D_{\hat{n}}^\dagger = e^{2a\hat{n}\cdot\mathbf{J}}$$

$$E = 1 \text{ at } a = 0$$

$$E \xrightarrow{a \rightarrow \infty} e^{2aj} |j, \hat{n}\rangle \langle j, \hat{n}|$$

3-hyperboloid
Radius a
Area $4\pi \sinh^2 a$

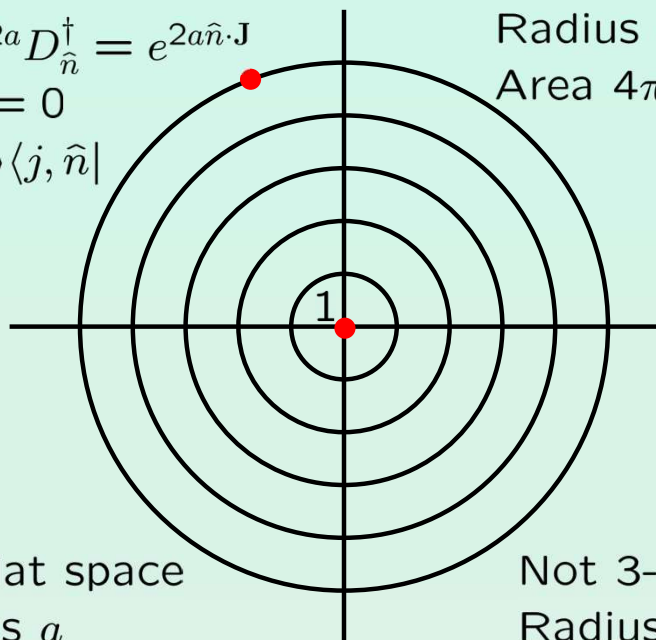

Not flat space
Radius a
Area $4\pi a^2$

Not 3-sphere
Radius a
Area $4\pi \sin^2 a$

$$E = e^{2a\hat{n}\cdot\mathbf{J}}$$

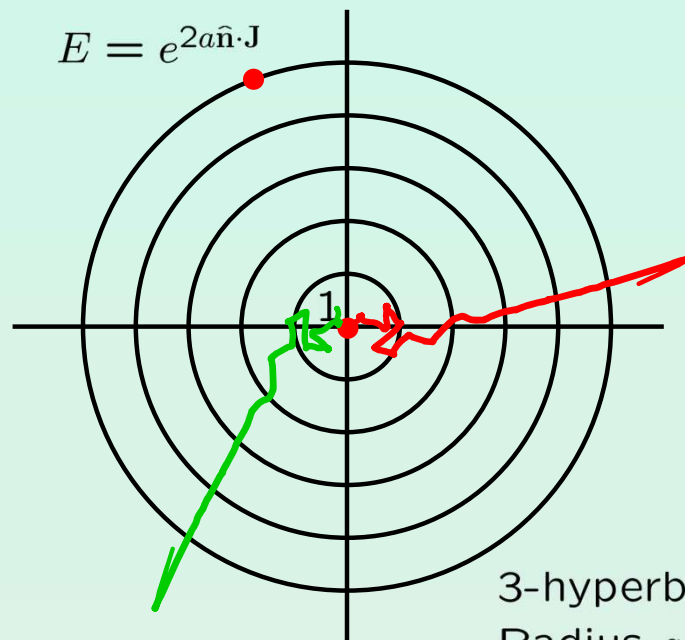

3-hyperboloid
Radius a
Area $4\pi \sinh^2 a$

Principal vs. chaotic instruments

SPQM and ISM are principal universal instruments, for which the universal instrumental group is finite-dimensional, because the nonlinear quadratic term has special properties. Principal instruments are very special: they approach a strong measurement of coherent states asymptotically; these instruments are thus universal (pre-quantum) and structure any Hilbert space in which they are represented. *They are what Heisenberg and Einstein meant by identifying what is observable.*

Generic measurements—two components of spin, two squeezing symplectic generators—have an infinite-dimensional universal instrumental group because of the nonlinear quadratic term. They do not have a representation-independent strong measurement, and the evolution of the instrument devolves into

C h a⁰ s

Chaotic instruments

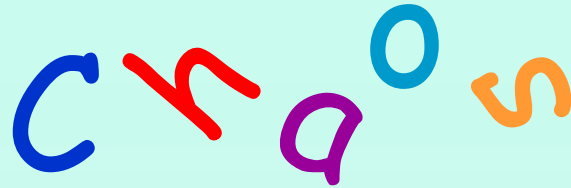

A universal chaotic instrument evolves stochastically into an increasing number of Lie-group dimensions. These Lie-group dimensions correspond to higher and higher powers of the measured observables and thus to finer and finer scales on a classical phase phase (sensitivity to initial conditions). Quantum chaos is what happens when the Lie-group dimensions, the higher powers, and the finer scales are cut off in a finite-dimensional Hilbert-space representation. All this is to be quantified by the entropies of the Kraus-operator distribution functions.

Discovery of universal chaotic instruments—and their quantum counterparts in finite-dimensional representations—promises a new group-theoretic method for analyzing quantum chaos and dynamical complexity.

Concluding paragraph of SPQM: Suffice it to say that we think we have found something: the home of quantum dynamics, the Lie-group manifold that supports all three faces of the trinity. The exhausted reader who has survived to read this concluding sentence of a very long paper might be pleased—or so we hope—to learn that our ambition is larger than was evident at the beginning.

Welcome to a
whole new world

A wide, flat beach at sunset. The sky is a mix of orange and purple, reflecting on the wet sand. Two people are walking away from the camera towards the horizon. The ocean is on the left, and the beach extends to the right.

**Cable Beach
Western Australia**